

# Operating Instructions

**Panasonic** **VHS**  
Professional/Industrial Video

**PRO  
LINE**

AG-1340

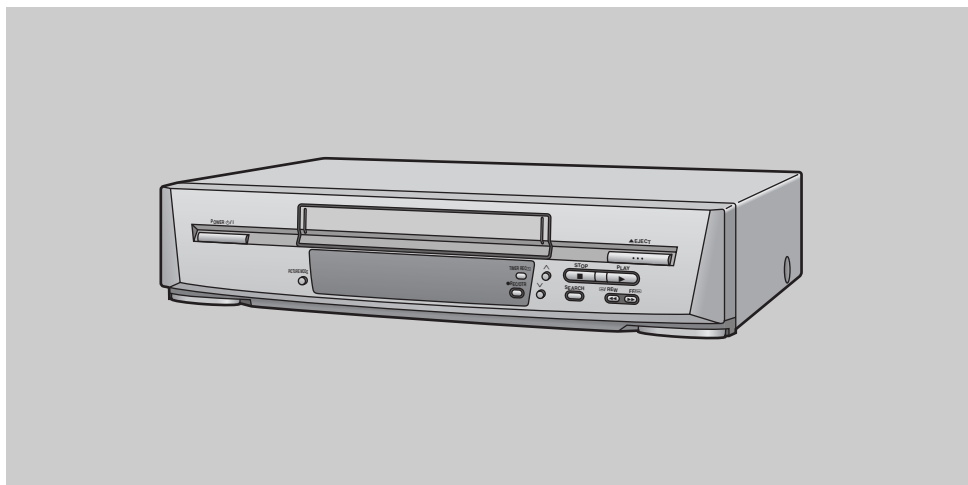

## Video Cassette Recorder

Before attempting to connect, operate or adjust this product,  
please read these instructions completely.

VQT9136

# Dear Customer

Thank you for purchasing this Panasonic Video Cassette Recorder.

We strongly suggest that you carefully study the Operating Instructions before attempting to operate the VCR, and that you note the listed precautions.

## ACCESSORIES

- 1 pc. Remote Controller
- 1 pc. Coaxial Cable
- 1 pc. AC Power Cord
- 2 pcs. "AA" size Batteries

Press [POWER  $\odot$ /I (VCR  $\odot$ )] to switch the VCR from on to standby mode or vice versa. In standby mode, the VCR is still connected to the main AC power.

### FCC NOTE:

This equipment has been tested and found to comply with Part 15 of the FCC Rules. These limits are designed to provide reasonable protection against harmful interference in a residential installation. This equipment generates, uses and can radiate radio frequency energy and, if not installed and used in accordance with the instructions, may cause harmful interference to radio communications. If this equipment does cause or receive interference, which can be determined by turning equipment off and on, the user is encouraged to try to correct the interference by one of the following measures:

- Reorient or relocate the receiving antenna.
- Increase the separation between the equipment and receiver.
- Connect the equipment into an outlet on a circuit different circuit from that to which the receiver is connected.
- Consult the dealer or an experienced radio/TV technician for help.

FCC Caution: Any changes or modifications not expressly approved by the party responsible for compliance could void the user's authority to operate this equipment.

**Trade Name:** Panasonic  
**Model No.:** AG-1340P

**Responsible party:**  
Matsushita Electric Corporation of America  
3330 Cahuenga Blvd. West, Los Angeles, CA 90068

**Support Contact:**  
Panasonic Broadcast & Television Systems Company 1-323-436-3500

This device complies with Part 15 of the FCC Rules. Operation is subject to the following two conditions:

- (1) This device may not cause harmful interference, and
- (2) this device must accept any interference received, including interference that may cause undesired operation.

## Plug in Auto Tuning

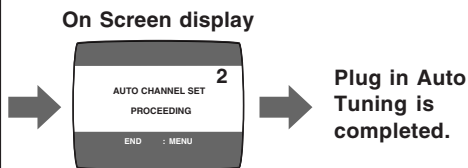
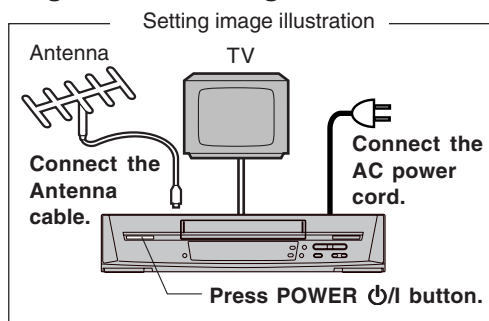

All broadcasting stations that can be received in the area are automatically tuned and stored in memory.

- Do not turn off the VCR halfway. (See pages 12-15.)

## WARNING

TO REDUCE THE RISK OF FIRE OR SHOCK HAZARD, DO NOT EXPOSE THIS EQUIPMENT TO RAIN OR MOISTURE.

## CAUTION:

TO REDUCE THE RISK OF FIRE, SHOCK HAZARD AND ANNOYING INTERFERENCE, USE THE RECOMMENDED ACCESSORIES ONLY.

DO NOT BLOCK ANY OF THE VENTILATION OPENINGS. INSTALL IN ACCORDANCE WITH THE MANUFACTURER'S INSTRUCTIONS.

DO NOT PLACE THIS APPARATUS INTO AN AUDIO RACK, BOOK SHELF OR SIMILAR LOCATION BECAUSE OF HEAT FROM THIS APPARATUS.



### CAUTION

RISK OF ELECTRIC SHOCK  
DO NOT OPEN



CAUTION: TO REDUCE THE RISK OF ELECTRIC SHOCK, DO NOT REMOVE COVER (OR BACK). NO USER-SERVICEABLE PARTS INSIDE. REFER SERVICING TO QUALIFIED SERVICE PERSONNEL.

This symbol alerts the user that important literature concerning the operation and maintenance of this unit has been included.

Therefore, it should be read carefully in order to avoid any problems.

This symbol warns the user that uninsulated voltages within the unit may have sufficient magnitude to cause electric shock. Therefore, it is dangerous to make any kind of contact with any inside part of this unit.

### Note to CATV system installer:

This reminder is provided to call the CATV system installer's attention to Article 820-40 of the NEC that provides guidelines for proper grounding and, in particular, specifies that the cable ground shall be connected to the grounding system of the building; as close to the point of cable entry as practical.

# Contents

## *Before Use*

Controls and Connection Sockets .....	4
Infrared Remote Controller .....	6
Remote Controller Setup .....	8

## *Setting Up*

Connections .....	9
Tuning the TV to your VCR .....	12
– Plug in Auto Tuning .....	12
Storing TV Broadcasts in your VCR .....	14
Language Setting of the On Screen Display .....	16
Setting the Clock of your VCR .....	17
Settings Using the On Screen Display .....	18

## *Basic Operations*

Playback .....	21
– Jet Search .....	22
– Other Playback Functions .....	22
Manual Recording .....	24
– One-Touch Recording (OTR) .....	26

## *Advanced Operations*

Timer Recording .....	27
– 4-Key Programming .....	27
Search Functions .....	30
– Jet Navigator .....	30
– Time Stamp Function .....	32
– VHS Index Search System .....	33
– Intro-Jet Scan .....	33
Editing .....	34
– Assembly Editing .....	34
Other Functions .....	35
– Other Automatic Functions .....	35

## *Helpful Hints*

Before Requesting Service .....	36
Usage Precautions .....	38
Specifications .....	40

# Controls and Connection Sockets

This section describes in detail the function of each button, switch and connection socket.

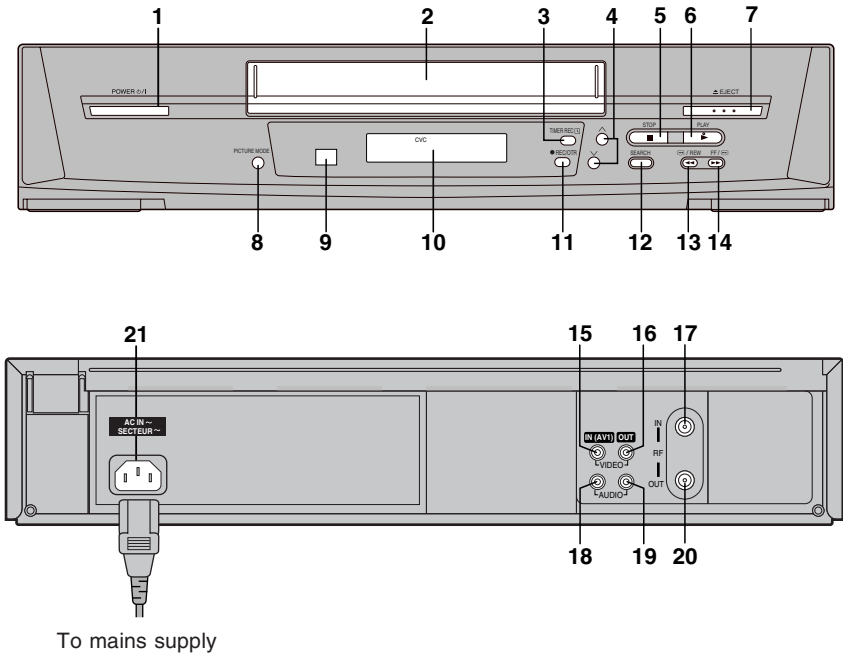

## FRONT

- 1 POWER  $\text{\textcircled{P}}$ /I (VCR  $\text{\textcircled{P}}$ ) (☞ 12)
- 2 Cassette Compartment (☞ 21)
- 3 TIMER REC  $\text{\textcircled{R}}$  (TIMER  $\text{\textcircled{R}}$ ) (☞ 28)
- 4  $\nabla \ \blacktriangle$  (☞ 13, 35)
- 5 STOP  $\blacksquare$  (☞ 21, 24)
- 6 PLAY  $\blacktriangleright$  (☞ 21)
- 7  $\blacktriangle$  EJECT (☞ 13)
- 8 PICTURE MODE (☞ 19, 23)
- 9 Infrared Remote Control Receiver Window
- 10 Display
- 11  $\bullet$  REC/OTR (☞ 24, 26)
- 12 SEARCH (☞ 33)
- 13 REW (REWIND)  $\blacktriangleleft\blacktriangleleft$  (☞ 21)
- 14 FF (FAST FORWARD)  $\blacktriangleright\blacktriangleright$  (☞ 21)

## REAR

- 15 VIDEO IN (AV1) (☞ 34)
- 16 VIDEO OUT (☞ 10)
- 17 RF IN (☞ 9)
- 18 AUDIO IN (AV1) (☞ 34)
- 19 AUDIO OUT (☞ 10)
- 20 RF OUT (☞ 9)
- 21 AC Input Socket (☞ 9)

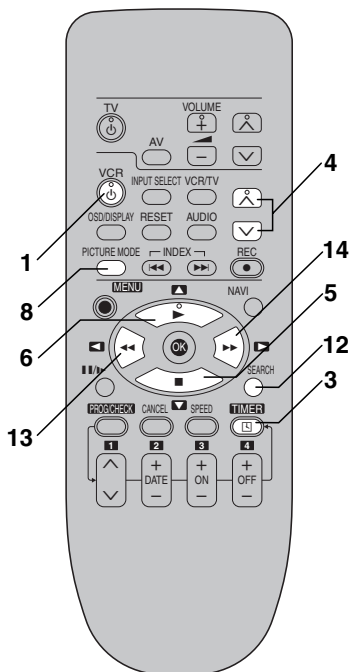

# Infrared Remote Controller

The remote control unit for this VCR is a universal remote controller. As such, some of its buttons are not used to operate this VCR.

## VCR OPERATION

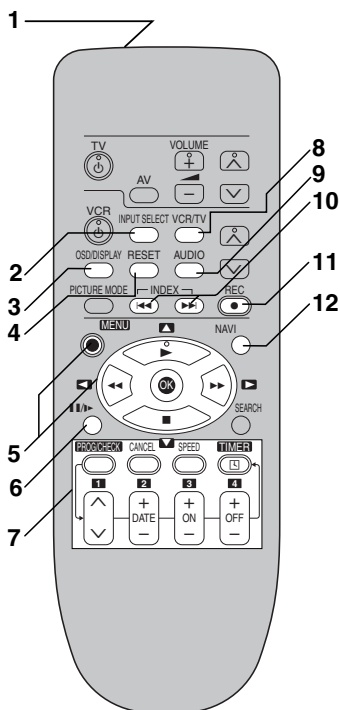

### 1 Infrared Transmitter

### 2 INPUT SELECT (☞ 34)

### 3 OSD/DISPLAY (☞ 18, 25)

### 4 RESET (☞ 18)

### 5 On Screen Display Menu Operation Buttons (☞ 14)

MENU

OK

▲▼◀▶

### 6 II/II> (PAUSE/SLOW) (☞ 21)

### 7 Timer Recording Operation Buttons (☞ 27-29)

✓ ^, DATE, ON, OFF

PROG./CHECK

CANCEL

SPEED

TIMER ☐

### 8 VCR/TV (☞ 12)

### 9 AUDIO

This button is not used to operate this VCR.

### 10 INDEX ◀◀, ▶▶ (☞ 33)

### 11 REC ● (☞ 24)

### 12 NAVI (☞ 30)

## TV OPERATION

Only Panasonic TVs can be operated with the provided remote control. The settings for operating the TV with the remote control have already been made.

No additional settings need to be performed.

However, some Panasonic TVs cannot be operated using this remote control.

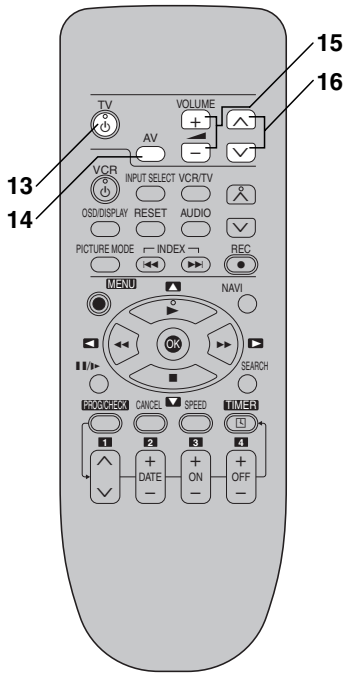

### 13 TV

Press to switch the TV from on to standby mode or vice versa. In standby mode, the TV is still connected to the mains.

–With some TV models, it may only be possible to switch the TV to the standby mode using this button.

In this case, use [AV] or the and buttons to switch the TV on.

–Ensure that [VCR/TV] switch is set to [TV].

### 14 AV

Selects TV input or AV input.

### 15 VOLUME

Adjusts the volume of the TV.

### 16

Selects the required program position (TV station) of the TV.

–Ensure that [VCR/TV] switch is set to [TV].

# Remote Controller Setup

## Installing the Batteries

Insert the batteries with the polarity ( $\oplus$  and  $\ominus$ ) correctly aligned.

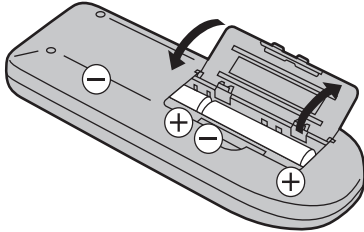

### Power Source for the Remote Controller:

The remote controller is powered by 2 AA, UM3 or R6 size batteries. The life of the batteries is about one year, although this depends on the frequency of use.

### Precautions for Battery Replacement:

- Load the new batteries with their polarity ( $\oplus$  and  $\ominus$ ) aligned correctly.
- Do not apply heat to the batteries, or an internal short circuit may occur.
- If you do not intend to use the remote controller for a long period of time, remove the batteries and store them in a cool and dry place.
- Remove spent batteries immediately and dispose of them.
- Do not use an old and a new battery together, and never use an alkaline battery with a manganese battery.
- Do not use rechargeable batteries.



# Connections

This section shows you how to connect the VCR to an antenna, TV, etc.

**When the VCR is turned on after connecting the antenna cable and the AC power cord, Plug in Auto Tuning starts automatically.**

## Basic Connections

The following connections are required to record and play back the video cassette through the TV.

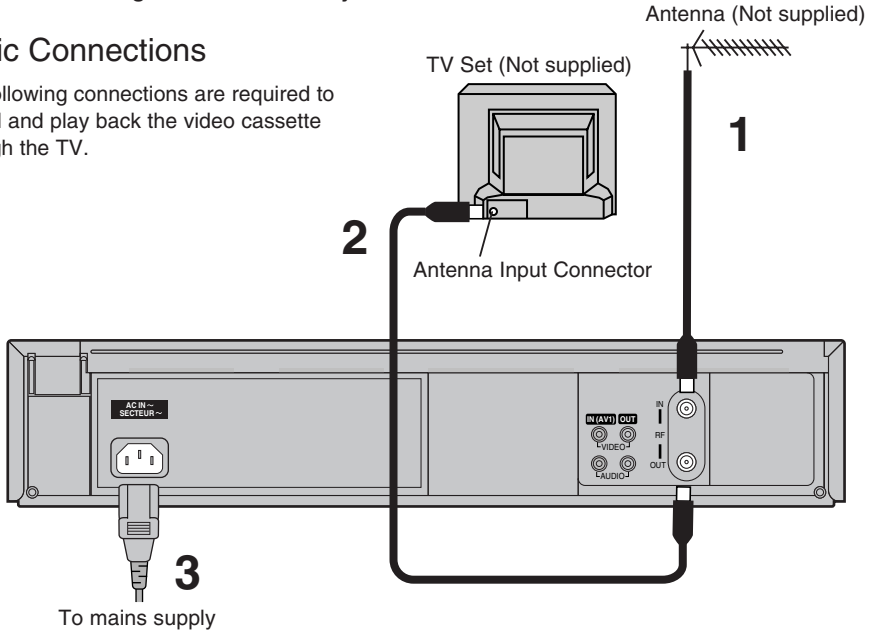

# Connection to a TV using the Audio/Video Input Sockets

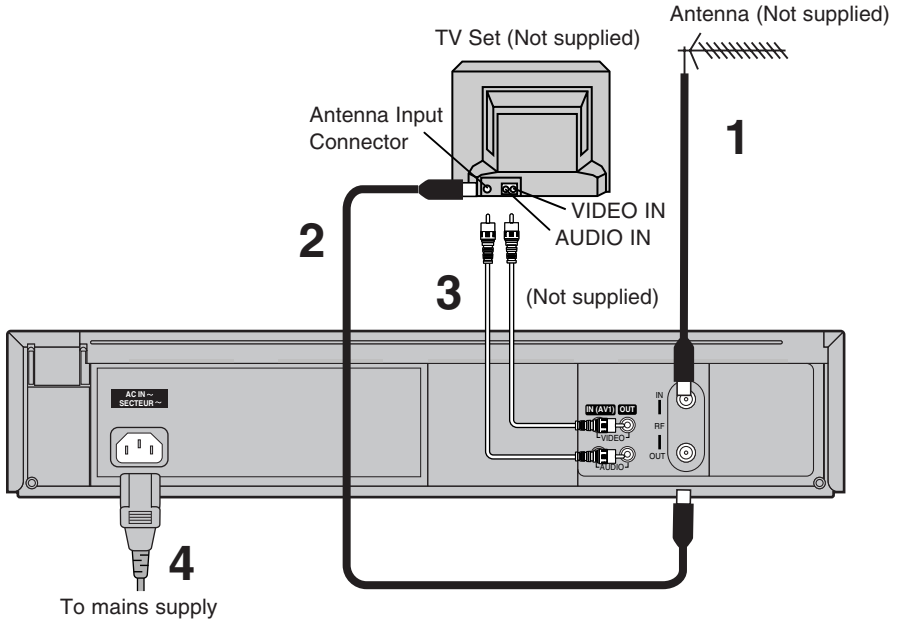

## Cable Connection

### Cable-VCR-TV (For CATV/PAY Channels Recording/Playback)

The VCR has an extended range, and can tune the Low-Band, Mid-Band, Super-Band, Hyper-Band, Ultra-Band, and Special cable channels (Channels A-5-A-1, A-W, AA-FFF, GGG-WWW, WWW+1-WWW+12, 100-125, 5A). Also, the VCR can tune to any of the 56 UHF channels (14-69). Refer to Storing TV Broadcasts in your VCR on page 15.

### BASIC Hook-Up

Since the VCR can tune Mid and Super Bands, this connection will provide the reception of all cable channels except those which are intentionally scrambled.

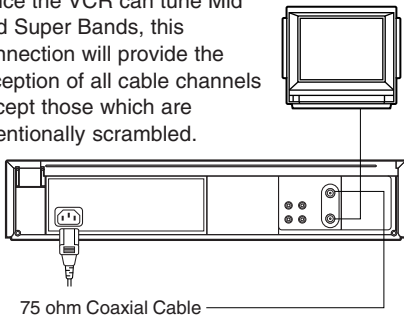

However, if you subscribe to a special channel which is scrambled you will probably have a descrambler box for proper reception. The VCR by itself cannot properly receive a scrambled program since it does not contain a descrambler. In order for the VCR to properly receive a scrambled program, your existing descrambler must be used. There are two commonly used methods of connection in this case.

### Typical Cable System Hook Ups with Cable Converter/Descrambler Boxes

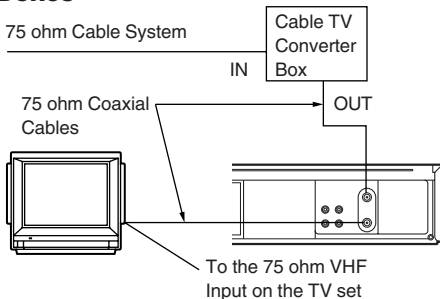

The cable hook-up shown at the bottom left allows VCR-TV functions except for viewing one channel while recording another.

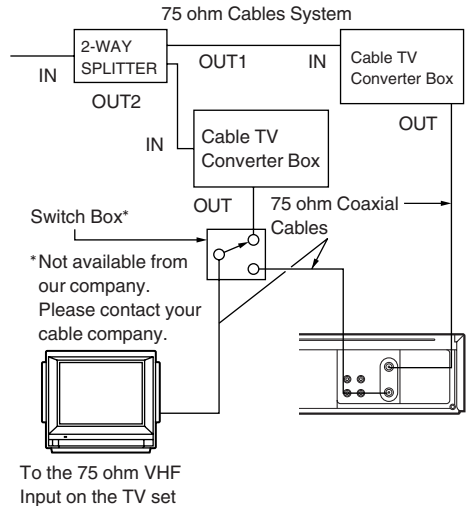

The above cable hook-up allows VCR functions, including viewing one channel while recording another, but it requires two cable TV Converter/Descrambler Boxes, one Switch Box and one 2-Way Splitter.

Since the VCR has an extended range of tuning, tuning-programing of non-scrambled Mid-Band and Super-Band TV programs is possible. When a cable converter or descrambler box is connected to the VCR, all timer-controlled recording functions will continue to operate with the exception of changing channels automatically. CATV Channel selection will have to be performed with the cable converter. Timer-controlled recording from CATV Channels is therefore limited to one channel at any given time.

# Tuning the TV to your VCR

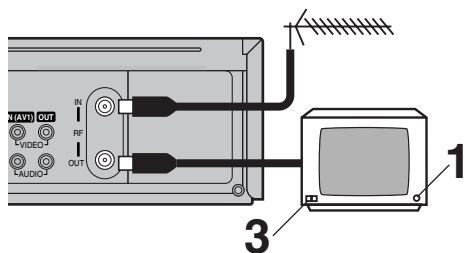

The VCR is fitted with its own tuner (just like a normal TV) and can be preset to receive up to 181 TV broadcast stations.

## Plug in Auto Tuning

Auto Tuning searches for TV stations from VHF minimum to UHF maximum and memorizes every tuned program position.

### Notes:

- If the VCR is turned on with the antenna not connected, all channels are skipped.
- When Auto Tuning is canceled halfway, Auto Tuning is not executed even if the VCR is turned off and then turned on again. In this case, see page 13 “To Restart Plug in Auto Tuning”.

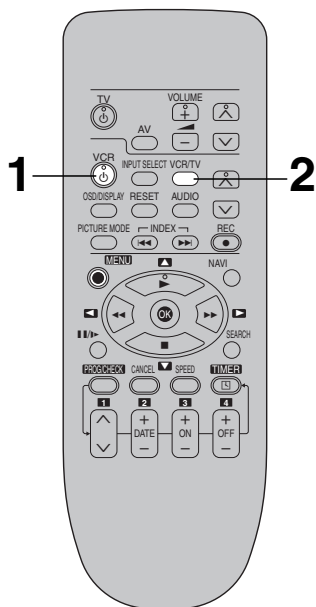

- 1 Press [POWER  $\odot$ /I (VCR  $\odot$ )] to turn on the TV and VCR after connecting the antenna cable and the AC power cord, Auto Tuning starts.

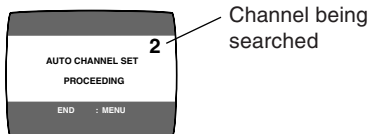

Channel being searched

- Auto Tuning will stop halfway by turning the VCR off, pressing [MENU], playback or a power failure during Auto Tuning.
- When there are 5 more CATV channels, the antenna system CATV is automatically selected; when there are 4 or fewer CATV channels, the TV is selected. If a change is required, conduct the resetting procedure described in step 4 on page 14.

- 2 Press [VCR/TV] to select the VCR mode.

The VCR supplies a signal to the TV via the RF coaxial cable on channel US3 or 4.

It is possible to view the video picture on your TV in the same way that you watch TV broadcasts.

If you have connected the VCR to the TV through the video and audio input sockets, then you do not need to follow the procedure below.

**When the VCR is turned on after unpacking and connecting the antenna cable and the AC power cord, Plug in Auto Tuning starts automatically.**

- 3 Select a program number on the TV which you wish to use as the video viewing channel. Then tune in the TV to the picture from the screen being auto tuned or the screen selected with the  $\nabla$  and  $\wedge$  buttons of the VCR.

–During Auto Tuning, the TV program screen does not appear, and the Auto Tuning screen appears instead.

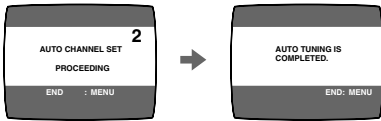

### To Cancel Auto Tuning Mid-Operation

Press [MENU] during Auto Tuning. Auto Tuning is cancelled.

### To Restart Plug in Auto Tuning

- 1 Press [EJECT] and remove the video cassette.
- 2 Keep the  $\nabla$  and  $\wedge$  buttons on the VCR pressed simultaneously for 3 seconds or more during the VCR on.
  - The channel displayed on the VCR display disappears for a moment then changes to 2.

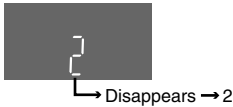

- 3 Disconnect the mains lead and then reconnect it.
- 4 Turn off the VCR and then turn it on. Press [VCR/TV] to select the VCR mode.
  - Auto Tuning commences.

### If Auto Tuning stops halfway by turning the VCR off, playback or a power failure:

- 1 Disconnect the mains lead and then reconnect it.
- 2 Turn off the VCR and then turn it on.
  - Auto Tuning commences.

### To Change the RF Output Channel

In some rare cases after tuning the TV to your VCR, interference may be visible on the picture. To get rid of this interference, you can manually adjust the RF output channel a few channels up and down from the current setting. The procedure is described below.

- 1 Hold down [MENU] for 5 seconds or more.
  - The VCR display changes as shown below and the VCR picture on the TV displays this pattern.

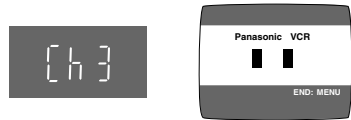

- 2 Enter the desired channel number (US3 or US4) by the  $\nabla$  and  $\wedge$  buttons.

3  $\leftrightarrow$  4

- 3 Press [MENU] to finish the setting mode.
- 4 Retune your TV to the new RF channel for the VCR.

#### Note:

– Even if the RF output channel has been changed, it is not necessary to perform Auto Tuning.

# Storing TV Broadcasts in your VCR

## Auto Tuning Using the On Screen Display

The VCR is tuned automatically by Plug in Auto Tuning. However, Auto Tuning using the On Screen Display should be performed according to the following method if necessary.

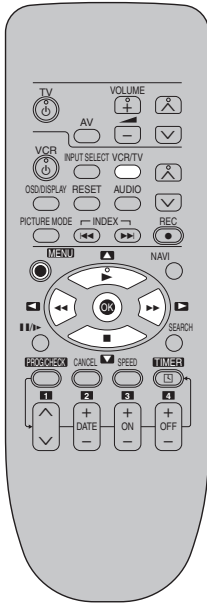

### Notes:

- Auto Tuning searches for TV stations from VHF minimum to UHF maximum and memorizes every tuned program position. Other program positions are skipped.
- Auto Tuning takes three or more minutes to complete its search.
- If the VCR is not correctly tuned by Auto Tuning, follow the procedure on the next page.

### Preparations

- Confirm that the TV is on and the VCR viewing channel is selected.
- Turn on the VCR and select any program position except AV input.
- Press [VCR/TV] to select the VCR mode.

### Operations

1 Press [MENU].

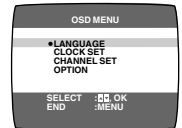

2 Select [CHANNEL SET] by pressing ▲ or ▼ and then press [OK].

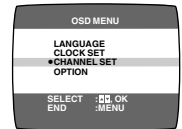

3 Select [ANTENNA SYSTEM] by pressing ▲ or ▼ and then press [OK].

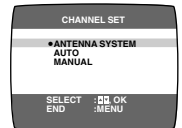

4 Select the desired system by pressing ▲ or ▼ and then press [MENU].

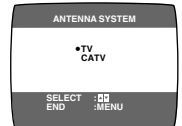

5 Select [AUTO] by pressing ▲ or ▼ and then press [OK].

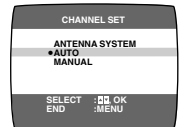

- When Auto Tuning is completed, the on screen display disappears and the lowest channel position at which a broadcast can be tuned in is received.

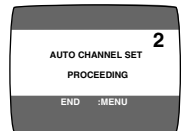

## Manual System Setting Procedure

Follow steps 1 to 4 on page 14.

- 5 Select [MANUAL] by pressing ▲ or ▼ and then press [OK].

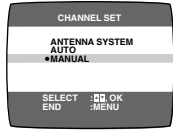

- 6 Select [CH] by pressing ▲ or ▼ and then select the program position by pressing ◀ or ▶.

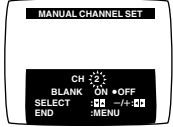

- 7 Select [BLANK] by pressing ▲ or ▼ and then select [ON] or [OFF].

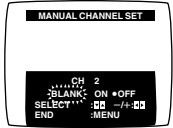

- To select the blanking of a program position, select [ON].
- Repeat steps 6 and 7 for another unoccupied program positions to skip during the selection of the program positions.

- 8 Press [MENU] three times.

## Channel Plan TV mode

CHANNEL DESIGNATIONS	CHANNEL RECEIVED OF THE AIR	CHANNEL SELECTION & INDICATION ON VCR
VHF	2-13	2-13
UHF	14-69	14-69

## CATV mode

CHANNEL DESIGNATIONS	CHANNEL RECEIVED FROM CABLE	CHANNEL SELECTION & INDICATION ON VCR
BROADCAST VHF	2-13	2-13
CATV LOW BAND	A-5-A-1	95-99
CATV MID/SUPER BANDS	A-W	14-36
CATV HYPER BAND	AA-FFF	37-65
ULTRA BAND	GGG-WWW WWW+1- WWW+12	66-94
	100-125	100-125
SPECIAL CATV CHANNEL	5A	1

# Language Setting of the On Screen Display

## Preparations

- Confirm that the TV is on and the VCR viewing channel is selected.
- Turn on the VCR.
- Press [VCR/TV] to select the VCR mode.

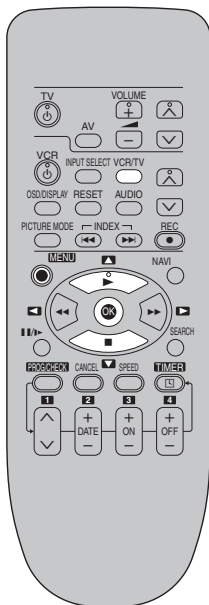

## To Select the Desired Language

Select one of the four languages displayed: English, Spanish, Portuguese and French.

- 1 Press [MENU].

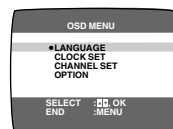

- 2 Select [LANGUAGE] by pressing ▲ or ▼ and then press [OK].

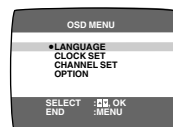

- 3 Select the desired language by pressing ▲ or ▼.

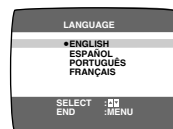

- 4 Press [MENU] twice.



# Setting the Clock of your VCR

The built-in digital clock is used to activate the timer for automatic recording and must be set to the correct time. It employs the 24-hour system.

## Preparations

- Confirm that the TV is on and the VCR viewing channel is selected.
- Turn on the VCR.
- Press [VCR/TV] to select the VCR mode.

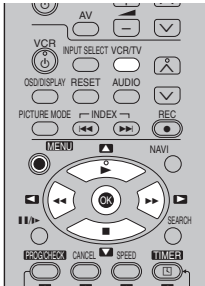

Example:  
Date: 16 October (During daylight saving time), 2005

Time: 20:15

## Operations

1 Press [MENU].

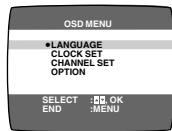

2 Select [CLOCK SET] by pressing ▲ or ▼ and then press [OK].

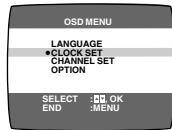

3 Set [D.S.T.] (Daylight Saving Time) by pressing ▲ or ▼.

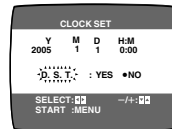

- Select [YES] to set daylight saving time. The time on the clock is advanced by 1 hour.
- Select [NO] to return to standard time. The time on the clock is set back by 1 hour.
- Press ► to set each time.
- Press [MENU] when not setting each time.

4 Set each item by pressing ▲ or ▼ and ►. Press ◀ to return to the previous item.

Set [Year] to [2005].

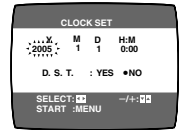

Set [Month] to [10].

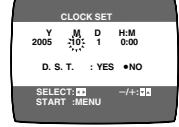

Set [Date] to [16].

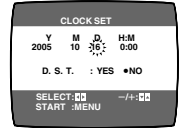

Set [Time] to [20:15].

- When it is kept pressed, the indication changes in 30-minute steps.

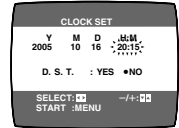

- There is no need to press ►.

5 Press [MENU].

- The clock starts.



## Note:

- The clock operates for at least 5 years on its backup system in the event of a power failure.

## Time Reset Function

If the clock is less than two minutes slow or fast, it can easily be reset to the proper time.

Example: Resetting the clock to 12:00.00

- 1 Select [CLOCK SET] from the OSD menu and press [OK].
- 2 When the current clock display on the VCR is between 11:58.00 and 12:01.59, press [MENU] as soon as you hear the 12:00.00 signal. This resets the time to 12:00.00.

# Settings Using the On Screen Display

## Preparations

- Confirm that the TV is on and the VCR viewing channel is selected.
- Turn on the VCR.
- Press [VCR/TV] to select the VCR mode.

## On Screen Display

1 Press [MENU].

2 Select [OPTION] by pressing ▲ or ▼ and then press [OK].

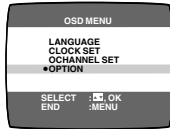

3 Select [OSD] by pressing ▲ or ▼.

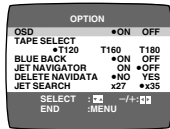

4 Select [ON] or [OFF] by pressing ◀ or ▶.

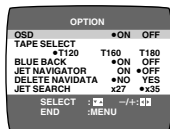

ON: The on screen display will appear on the TV screen for 5 seconds.

-The on screen display will always appear on the TV screen during rewind and fast forward.

OFF: The on screen display will not appear.

5 Press [MENU] twice to make the on screen display disappear.

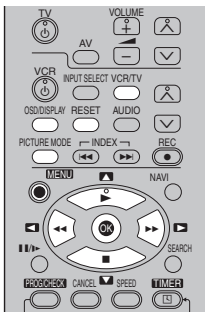

## To Use the On Screen Display

Press [OSD/DISPLAY].

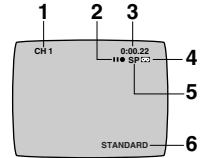

1 Program position

2 Tape running display

Stop, Eject

Rewind, Review, Index Search, JET SEARCH (backward)

Fast forward, Cue, Index Search, JET SEARCH (forward)

Playback

Recording

Recording pause

Repeat playback

3 Present time/Tape counter/Remaining tape time/Index search

Information	Display
Present time	17:24
Tape counter	-2:35.47
Remaining tape time	REMAIN 2:34
Index search	S 01

Press [RESET] to reset the tape counter (elapsed time) to [0:00.00].

-The tape counter is automatically reset to [0:00.00] when a video cassette is inserted.

4 Cassette-in indicator

5 Tape speed indicator

### 6 Picture mode indicator

At each press [PICTURE MODE], the selected picture mode is set and following picture mode indicators appear.

- STANDARD: For TV program recorded
- DYNAMIC: For Scenery, Sports
- SOFT: For Rental soft tape
- CARTOON: For Cartoon

#### Notes:

- The on screen display may be disturbed depending on the playback tape or the input signal.
- The on screen display does not appear when the [OSD] is set to [OFF]. Set the [OSD] to [OFF] for dubbing.

## To Select the Corresponding Video Cassette Tape Length to Display the Approximate Remaining Tape Time

Follow steps 1 to 2 on page 18.

- 3 Select [TAPE SELECT] by pressing **▲** or **▼**.

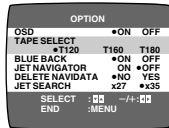

- 4 Select the corresponding video cassette tape length by pressing **◀** or **▶**.

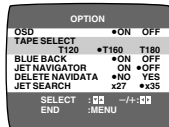

- T120: For T30, -60, -90 and -120 tapes.
- T160: For T140 and -160 tapes.
- T180: For T180 tape.

- 5 Press [MENU] twice to make the on screen display disappear.

## For the Blue Background Function

When [BLUE BACK] is [ON], the screen will always have a blue background when you play back the unrecorded portions. Follow steps 1 to 2 on page 18.

- 3 Select [BLUE BACK] by pressing **▲** or **▼**.

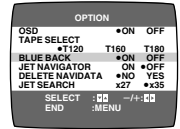

- 4 Select [ON] or [OFF] by pressing **◀** or **▶**.

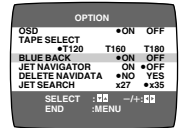

- When [BLUE BACK] is [OFF], the blue background function is deactivated.
- It is not possible to record the blue picture of the blue background function.

- 5 Press [MENU] twice to make the on screen display disappear.

## For the Jet Navigator Function

Follow steps 1 to 2 on page 18.

- 3 Select [JET NAVIGATOR] by pressing **▲** or **▼**.

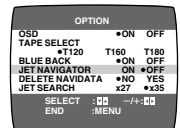

- 4 Select [ON] or [OFF] by pressing **◀** or **▶**.

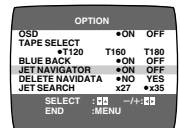

- When [JET NAVIGATOR] is [ON], **JN** appears on the VCR display and Jet Navigator function works.

- 5 Press [MENU] twice to make the on screen display disappear.

- See pages 30-32 for details on the Jet Navigator function.

## To Delete All the Jet Navigator Data Stored in the VCR's Memory

Follow steps 1 to 2 on page 18.

- 3 Select [DELETE NAVIDATA] by pressing ▲ or ▼.

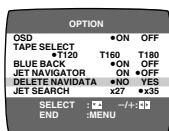

- 4 Select [YES] by pressing ◀ or ▶ then press [OK] when you want to delete all the Jet Navigator data.

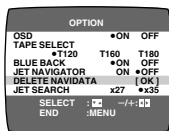

- 5 Press [MENU] twice to make the on screen display disappear.

–See page 31 on the way to delete the Jet Navigator data of a single video cassette tape.

## To Select the Jet Search Speed in the EP mode

Follow steps 1 to 2 on page 18.

- 3 Select [JET SEARCH] by pressing ▲ or ▼.

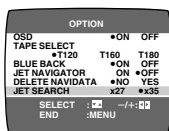

- 4 Select [x27] or [x35] by pressing ◀ or ▶.

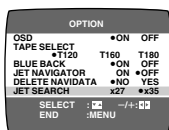

–It is possible to view the picture recorded in the EP mode at approx. 27 or 35 times speed.

- 5 Press [MENU] twice to make the on screen display disappear.

–See page 22 for details on the Jet Search function.

# Playback

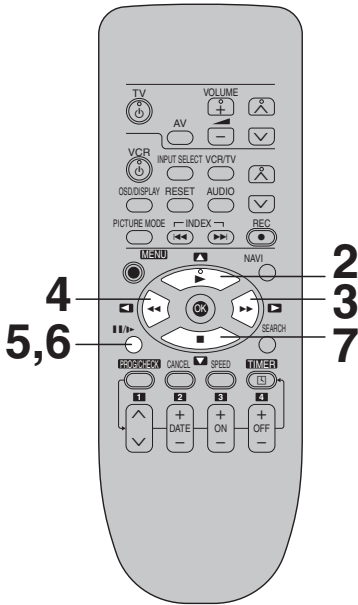
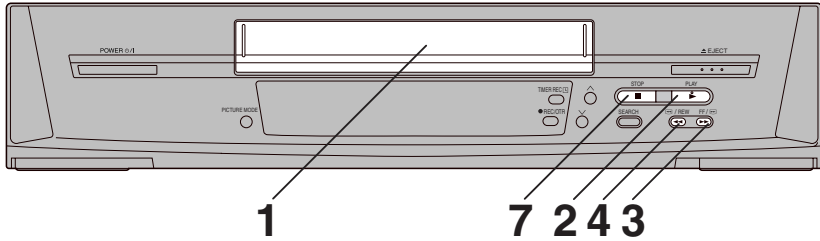

## Operations

- 1 Insert a recorded video cassette tape.
- 2 Start viewing the picture by pressing [PLAY].
- 3 Search forward by tapping [FF].  
– To change back to normal playback, press [PLAY].



- 4 Search backward by tapping [REW].  
– To change back to normal playback, press [PLAY].
- 5 View a still picture by pressing [PAUSE/SLOW].  
– To continue normal playback, press [PLAY] or [PAUSE/SLOW].
- 6 View a slow motion picture.  
– Keep [PAUSE/SLOW] pressed for 2 seconds or more.  
– To continue normal playback, press [PLAY].
- 7 Stop viewing the picture by pressing [STOP].



### Note:

– If you keep [FF] or [REW] pressed in step 3 or 4, search playback is activated while the button is pressed, and operation returns to normal playback when the button is released.

## To Obtain a Higher Speed Picture than Cue, Review (Jet Search)

Press [FF] or [REW] twice to search forward or backward during playback.

- Select search speed to view the picture recorded. (See page 20.)
- The picture that appears in the EP mode at approx. 35 times speed may be disturbed. A vertical scroll may happen due to combination with the TV monitor. It is not a malfunction but if it happens, change to approx. 27 times speed.
- Jet Search function also works during fast forward or rewind.
- The picture may not be in color or be distorted depending on TV.
- Press [PLAY] to cancel the Jet Search.

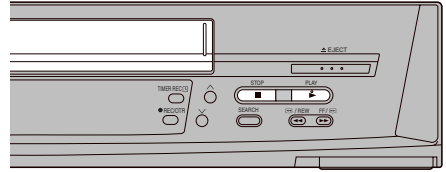
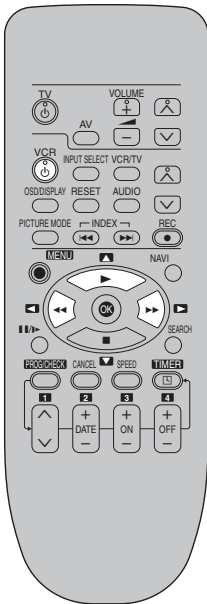

## Other Playback Functions

### To Stop Playback Automatically (Playback Off Timer Function)

Whenever you are playing back and wish to stop the tape automatically, simply set the playback duration by pressing [PLAY] on the VCR repeatedly.

The duration indicated on the VCR display changes by pressing [PLAY] as follows.

- Counter display (normal playback mode)
  - 30 (min.)→60 (min.)→ 120 (min.)→
  - 180 (min.)→240 (min.)→
- Counter display (normal playback mode)

Press [PLAY] on the VCR for 2 seconds or more during playback.

- The VCR will automatically switch off when Playback Off Timer is completed. To turn the VCR on again, press [POWER] (VCR).

#### Notes:

- The Playback Off Timer function works during normal playback.
- When the tape reaches its end during Playback Off Timer, the tape will be rewound to the start and the VCR will turn itself off.
- Repeat Playback function does not work during Playback Off Timer.
- Press [STOP] to stop midway.

## To Play back the Recorded Part Repeatedly

Keep [PLAY] pressed on the remote controller for 5 seconds or more.

The [R ►] indication appears on the TV screen.

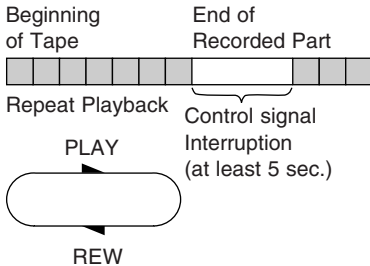

### Notes:

- Repeat Playback function does not work during Playback Off Timer.
- Press [STOP] to release the VCR from the Repeat Playback mode.

## To Playback in the Desired Picture Quality (Picture Mode)

This function reproduces optimum playback picture from various kind of recorded tapes and contents.

Press [PICTURE MODE] and select the corresponding Picture Mode as follows.

Mode	Characteristic	Example for Purpose
STANDARD	Normal	TV program recorded
DYNAMIC	Clear & Vivid	Scenery, Sports
SOFT	Mild	Rental soft tape
CARTOON	Delicate	Cartoon

- Pressing [PICTURE MODE] once makes the On Screen Display appear; after that, pressing it repeatedly changes the indication in the following order:

STANDARD (Initial Setting) → DYNAMIC → SOFT → CARTOON → STANDARD (Initial Setting)

## To Eject the Video Cassette Using the Remote Controller

Keep pressing [STOP] for at least 3 seconds.

### Notes:

- Jet Search, cue, review or slow playback will be automatically released after 10 minutes, and still playback, after 5 minutes.
- In the EP mode only:
  - When playing back a tape which was recorded on another VCR, it may be necessary to adjust tracking control using the  $\checkmark$  and  $\wedge$  buttons. (See page 35.) In some cases the picture quality may still be inferior. This is due to format constraints.

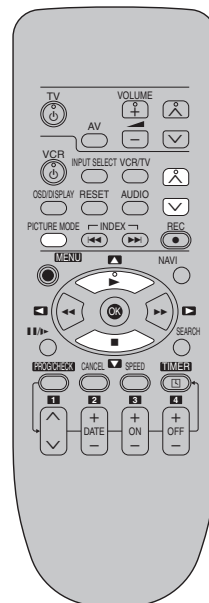

# Manual Recording

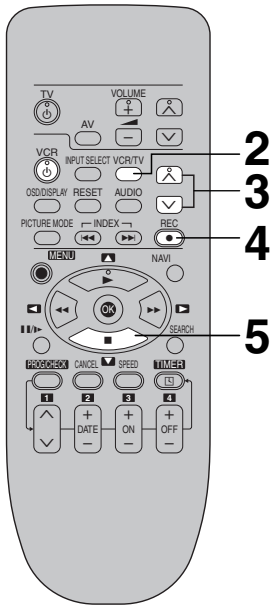
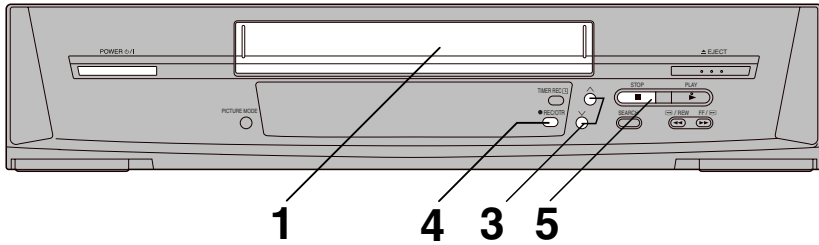

## Operations

- 1 Insert a video cassette tape with an intact erasure prevention tab.  
 – If it has already been inserted, press [POWER  $\phi$ /I (VCR  $\phi$ )] to turn the VCR on.
- 2 Press [VCR/TV] to select the VCR mode.
- 3 Press the  $\nabla$  and  $\blacktriangle$  buttons to select the TV station.  
 – If you press and hold down these buttons, the number of program position changes fast.
- 4 Press [REC (REC/OTR)] to start recording.
- 5 Press [STOP] to stop recording.





## To Select the Desired Tape Speed

Press [SPEED] before recording.

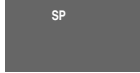

## To Interrupt Recording

Press [PAUSE/SLOW] during recording.

Press it again to continue recording.



## To View One TV Program while Recording Another One

- 1 Refer to steps 1–4 of the manual recording operation.
- 2 Press [VCR/TV] to select the TV mode.
- 3 Select the TV program on your TV that you wish to view now.

## To Display the Approximate Remaining Tape Time

- 1 Select [TAPE SELECT] from the on screen display and select the corresponding video cassette tape length. See page 19.

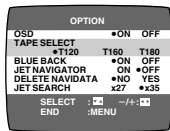

- T120: For T30, -60, -90 and -120 tapes.
- T160: For T140 and -160 tapes.
- T180: For T180 tape.

- 2 Press [OSD/DISPLAY].



The display changes as follows each time [OSD/DISPLAY] is pressed.

Clock→Counter→  
Remaining Tape Time→Clock

–The remaining tape time may not be displayed correctly depending on the tape used.

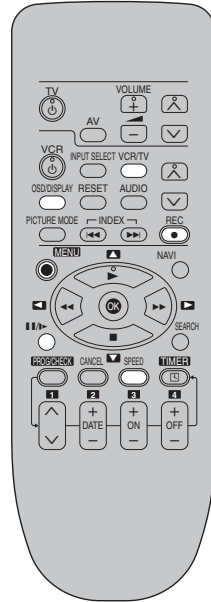

### Notes:

- When a video cassette with a broken off erasure prevention tab is inserted, the  indication will flash to indicate that recording is not possible even if [REC (REC/OTR)] is pressed.
- The recording pause mode will be automatically released after 5 minutes, and the VCR will return to the stop mode.

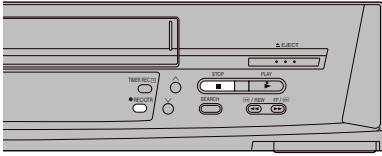

## One-Touch Recording (OTR)

Whenever you are in a hurry to start a timer recording with automatic stop in your absence, simply set the recording duration by pressing [REC/OTR] repeatedly.

The duration indicated on the VCR display changes by pressing [REC/OTR] as follows:

Counter display (normal recording mode)  
→30 (min.)→60 (min.)→120 (min.)→  
180 (min.)→240 (min.)→  
Counter display (normal recording mode)

### Preparation

– Insert a video cassette with an intact erasure prevention tab.

### Operations

- 1 Ready the video source which is to be recorded, and start recording.
- 2 Press [REC/OTR] on the VCR main unit repeatedly to select the desired recording duration.
  - The VCR will automatically switch off when OTR is completed. To turn the VCR on again, press [POWER ⏻/I (VCR ⏻)].

### Notes:

- The OTR function works during normal recording.
- When the tape reaches its end during OTR, the VCR will turn itself off.
- To stop OTR at any time, press [STOP] or [POWER ⏻/I (VCR ⏻)].

# Timer Recording

## 4-Key Programming

Up to 16 timer programs, including weekly and daily programs, can be recorded up to one month in advance by setting the timer.

### Preparations

- Insert a video cassette tape with an intact erasure prevention tab.
- Confirm that the TV is on and the VCR viewing channel is selected.
- Turn on the VCR.
- Check that the clock is set to the correct time. If it has not been set, refer to page 17.
- Press [VCR/TV] to select the VCR mode.

### Example:

Program position (channel); 2  
 Date; 27 October  
 Starting time; 20:02  
 Ending time; 21:30  
 (Present date; 16 October)

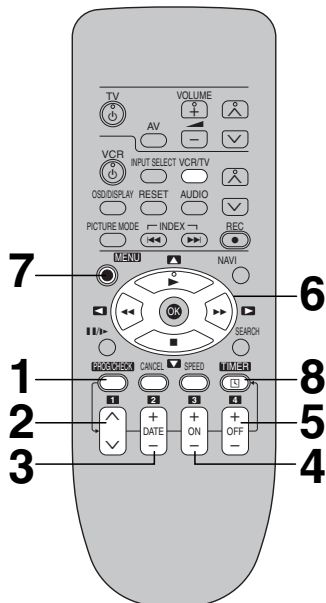

### Operations

- 1 Press [PROG./ CHECK].



- 2 Set Program position (channel) to 2.

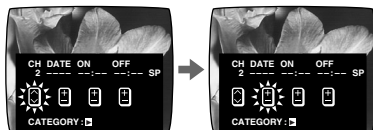

- The next item will flash after about 2 seconds.

- 3 Set Date to 27TH.

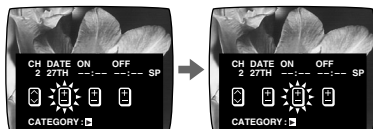

- 4 Set Starting time to 20:02.

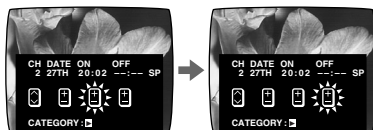

- When kept pressed, the indication changes in 30-minute steps.

- 5 Set Ending time to 21:30.



- 6 Press [▶] to select [CATEGORY SETTING]. Then, select the desired category by pressing [▲▼▶◀].

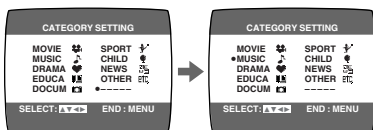

- Alternatively, you can set the category on the Navigator list. (See page 31 for details.)
- This function is activated when [JET NAVIGATOR] is set to [ON]. (See page 19.) When [JET NAVIGATOR] is set to [OFF], proceed to the step 8.

7 Press [MENU] to make the previous display appear.



8 To activate timer

- recording, press [TIMER].
- When [JET NAVIGATOR] is set to [ON], the [PROGRAM IS COMPLETED REMAINING PROGRAM 49] message appears. (See page 19.)
- When [JET NAVIGATOR] is set to [OFF], the [PROGRAM IS COMPLETED] message appears. (See page 19.)
- The VCR will be set to the timer recording standby mode after about 1 minute if [TIMER] is not pressed.

## Weekly Timer Recording

In step 3, select the desired day by pressing [DATE -].

For example, SU (Sunday)



(SU=Sunday, MO=Monday, TU=Tuesday, WE=Wednesday, TH=Thursday, FR=Friday, SA=Saturday)

## Daily Timer Recording

For this timer function, several groups of days can be selected.

- (A) Daily recording from Monday to Friday (MO-FR)
- (B) Daily recording from Monday to Saturday (MO-SA)
- (C) Daily recording from Sunday to Saturday (SU-SA)

In step 3, select the desired days by pressing [DATE -].

For example, ☉



## Timer Recording from an External Signal Source

If timer recording is performed by a unit connected to the audio/video input sockets, select the AV input indicator in step 2 for the program position.



## Setting other Programs in Succession

Repeat steps 1-8.

## Selecting the Desired Tape Speed

Press [SPEED] to make the selection in any of steps 1-5.



## Programming a Timer Recording of a TV Program Until its End

### (Auto SP/EP Change Function)

If, during a timer recording performed in the SP mode, the VCR determines that the remaining tape time is insufficient to record the program to its end, the Auto SP/EP Change function automatically changes the tape speed to EP to ensure that the whole program will be recorded. Depending on the remaining tape length, recording may be performed in the EP mode from the start. However, if the remaining tape time is still not sufficient in this case, the program cannot be recorded to the end.

### Example for T120 tape:

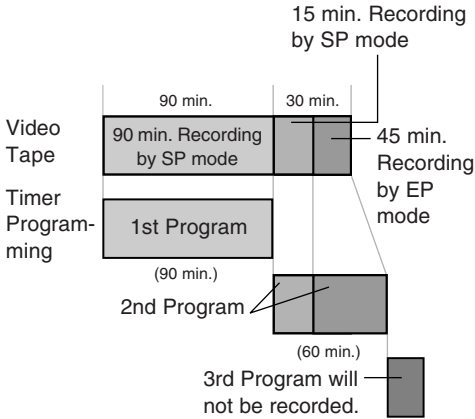

- The tape length must be set correctly. (See page 19.)
- Tapes except T30, -60, -90, -120, -140, -160, -180 tapes may not work correctly.

### To Activate the Auto SP/EP Change Function:

Press [SPEED] to select [A].



- Every time you press [SPEED], the indication changes in the following order:

SP → EP → **A** → SP

### Checking a Timer Program

- The VCR must be turned on, or the timer recording indicator "TV" lit.
- Confirm that the TV is on and the VCR viewing channel is selected.

- 1 Press [PROG./CHECK] twice.
  - Every time you press [PROG./CHECK], the program shifts below.

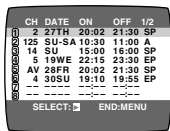

- 2 Press [VCR/TV] to select the VCR mode.

- 3 Press ► to display the Category. (When [JET NAVIGATOR] is set to [ON].) Press ► again to make the previous display appear.

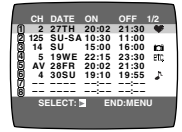

### Cancelling a Timer Program

- The VCR must be turned on, or in timer recording standby mode.
- Confirm that the TV is on and the VCR viewing channel is selected.

- 1 Press [PROG./CHECK] twice.

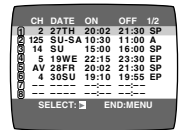

- 2 Press [VCR/TV] to select the VCR mode.

- 3 Press [PROG./CHECK] repeatedly.

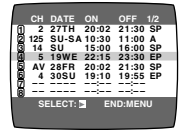

- 4 Press [CANCEL].

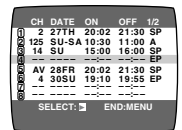

### Note:

- If timer recording is not completed (due to insufficient tape or cancellation by the user), the programmed timer recording data will be cancelled from the memory by 4 A.M. two days later. However, if the timer recording function is activated at that time, the programmed timer recording data will not be cancelled.

# Search Functions

## Jet Navigator

This VCR can display a list of the recorded programs on the inserted video cassette on the TV screen. You can then select the desired program, and the VCR will quickly locate its beginning and start playback.

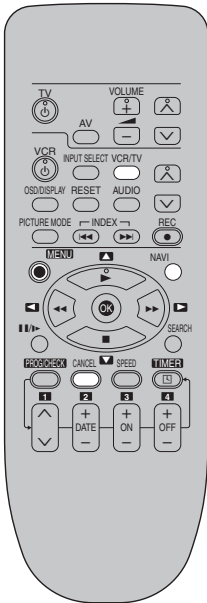

Conditions for correct operation of the Jet Navigator function:

- The tape length of the inserted cassette must be set correctly.
- The VCR must not be in the timer recording standby mode.
- A program of at least 15 minutes must be recorded on the tape.

### Preparations

- Display the VCR picture on the TV.
- Be sure to set [JET NAVIGATOR] to [ON] (See page 19.) and perform recording.
- Press [VCR/TV] to select the VCR mode.

### Operations

1 Press [NAVI] to display the Jet Navigator list.

- Up to 14 program data that have been recorded last are displayed on the Jet Navigator list.

JET NAVIGATOR			
CH	DATE	ON	CATEGORY
1	10/18	10:30	MUSIC
124	10/19	15:00	SPORT
5	10/21	22:15	
AV	10/23	20:02	
4	10/26	19:10	EDUCA
2	10/27	20:02	
5	10/27	20:30	

SELECT : NAVI, END : MENU

(7 program data for each page)

- When more than 15 programs have been recorded for one cassette, the program data are deleted from the first one.
- When pressing [NAVI] during playback, playback stops and the Jet Navigator list appears.

2 Press [NAVI] several times to select the program that you want to locate and play back.

After more than 3 seconds, the VCR starts the search for the beginning of the selected program and playback starts automatically.

- Every time you press [NAVI], the program shifts above.
- If, after playback has started, you want to search for the beginning of the same or another program, press [NAVI]. Playback stops and the Jet Navigator list appears.

JET NAVIGATOR			
CH	DATE	ON	CATEGORY
1	10/18	10:30	MUSIC
124	10/19	15:00	SPORT
5	10/21	22:15	
AV	10/23	20:02	
4	10/26	19:10	EDUCA
2	10/27	20:02	
5	10/27	20:30	

SELECT : NAVI, END : MENU



JET NAVIGATOR			
CH	DATE	ON	CATEGORY
1	10/18	10:30	MUSIC
124	10/19	15:00	SPORT
5	10/21	22:15	
AV	10/23	20:02	
4	10/26	19:10	EDUCA
2	10/27	20:02	
5	10/27	20:30	

SELECT : NAVI, END : MENU

### To cancel the Jet Navigator list:

Press [MENU].

## To Set the Category

The category setting allows you to find what kind of programs are recorded by the character and the icon indications.

Press ► while the Jet Navigator list appears.

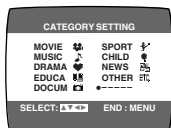

Category	Indication	Icon
MOVIE	MOVIE	
MUSIC	MUSIC	
DRAMA	DRAMA	
EDUCATION	EDUCA	
DOCUMENTARY	DOCUM	
SPORTS	SPORT	
CHILDREN	CHILD	
NEWS	NEWS	
OTHERS	OTHER	

## To Delete the Jet Navigator Data of a Single Video Cassette Tape:

Keep [CANCEL] pressed for more than 5 seconds while the Jet Navigator list appears. “- -” appears on the list.

– See page 20 on the way to delete all the Jet Navigator data stored in the VCR’s memory.

## Notes:

- The Jet Navigator list is stored in each cassette.
- Signals approximately 10 seconds before and after the current tape position are checked. (During this checking, [CHECKING JET NAVIGATOR DATA] is displayed on the TV screen.)
- Checking cannot be performed properly when signals are attempted to be checked at portions of the tape where there are no signals such as at unrecorded portions of the tape. In this case, press [NAVI] at a portion of the tape where a program has been recorded of this VCR. This will allow signal checking to be performed more reliably. When a signal can still not be found, [CAN NOT FIND JET NAVIGATOR DATA] is displayed on the TV and you cannot find the beginning of the program.
- Up to 20 cassettes and 50 programs can be registered.
- If 50 recorded programs data is already stored in memory and you attempt to store timer recording data for another program, the message [REMAINING PROGRAM “0” DELETE JET NAVIGATOR DATA] appears. If you attempt to make a new recording, this same message also appears after you insert the cassette and the Jet Navigator data is checked. As each timer recording or manual recording is finished, the program data is deleted, starting from the oldest data.
- When a new program is attempted to be recorded if programs equivalent to 20 cassettes are already stored in memory, [REMAINING CASSETTE “0” FOR JET NAVIGATOR DELETE JET NAVIGATOR DATA] is displayed. Programs recorded without deleting data as instructed are not registered in the list.

### When Recording Over the Same Location on a Tape:

- The originally recorded program is deleted from the list.
  - Program contents starting near the start and end of the newly recorded program (within 10 minutes before the start and after the end of the newly recorded program in the EP mode) are also erased.
- (Although old program contents are also similarly erased in the case of ordinary recording, the newly recorded program is not registered in the list.)

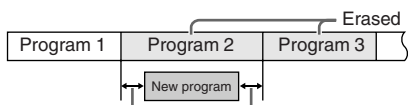

Within 10 minutes in the EP mode

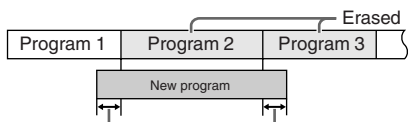

Within 10 minutes in the EP mode

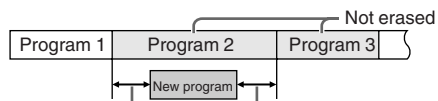

10 minutes or more in the EP mode

### To Check the Recorded Programming Data (Time Stamp Function)

When playback starts after searching with Jet Navigator function or index search function, recorded programming data (called Time Stamp) appears on the TV screen for approx. 5 seconds.

#### Preparations

- Display the VCR picture on the TV.
- Be sure to set [OSD] to [ON]. (See page 18.)
- Press [VCR/TV] to select the VCR mode.

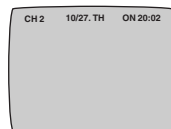

#### Note:

- Time Stamp does not appear if the beginning of the Jet Navigator data are not recorded 10 minutes before and after the current tape position in the EP mode even when index signals are recorded.

### To Demonstrate the Jet Navigator Function

Keep [NAVI] pressed for more than 5 seconds without inserting a cassette tape.



## To Find the Beginning of Each Recording (VHS Index Search System)

### Example:

Searching for the 2nd recorded segment in the forward direction.

Press [INDEX ►►] twice.

(This operation is performed while the VCR is in the stop mode or normal playback mode.)



- After finding the specific recorded segment, playback starts automatically.
- If you press [INDEX ►►] too many times, simply press [INDEX ◀◀] to correct it. In this way, you can reduce the displayed figure down to 1.
- Up to 20 index signals can be searched for in both directions.
- The figure on the display decreases by 1 each time an index signal is located.

### Recording Index Signals

Index signals are recorded in the following cases.

- When a recording is started by pressing [REC(REC/OTR)].
- When [REC] on the remote controller is pressed during recording.
- When timer recording is activated.

### Note:

- The index search function can only work correctly if the index signals are spaced at least 3 minutes apart in the SP mode and 5 minutes apart in the EP mode.

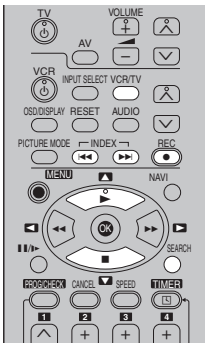

## Searching while checking the video cassette contents (Intro-Jet Scan)

The approximate beginnings of each recorded program are played in succession at the high speed so that the program to be viewed can be located easily.

### Preparations

- Confirm that the TV is on and the VCR viewing channel is selected.
- Press [VCR/TV] to select the VCR mode.
- Load the pre-recorded video cassette.

### Operations

- 1 Press [SEARCH].

(This operation is performed while the VCR is in the stop mode or normal playback mode with the VCR on.)

- The tape is rewound to the beginning, and played for about 10 seconds at the high speed. It is then fast forwarded, the VISS (VHS Index Search System) signals are searched in succession, and each time the signals are found, the tape is played for about 10 seconds at the high speed.

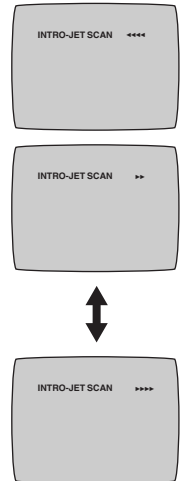

- 2 When the program to be viewed is reached, press [PLAY].

- Normal playback now commences.

### To stop the operation at any time:

Press [STOP].

### Note:

- This function may not work properly when recorded programs run for 15 minutes or less.

# Editing

## Assembly Editing

This function can be used to make up an edited tape from other recordings or video sources. A new scene can be added to the end of previous one.

### Preparations

- Connect a movie camera or another VCR to this VCR as shown.
- Insert a recorded cassette tape with an intact erasure prevention tab.
- Select the audio source required by pressing [INPUT SELECT] to set AV input.

### Operations

- 1 Search for the end of the previous recording by pressing [PLAY].
- 2 Press [PAUSE/SLOW].
- 3 Press [REC] to switch the VCR from the pause mode to the recording standby mode.
- 4 Start the new recording by pressing [PAUSE/SLOW] again.
- 5 Press [STOP] to stop recording.

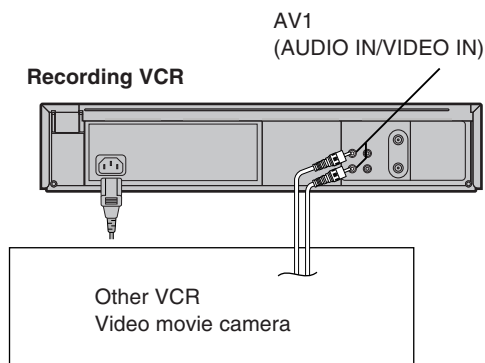
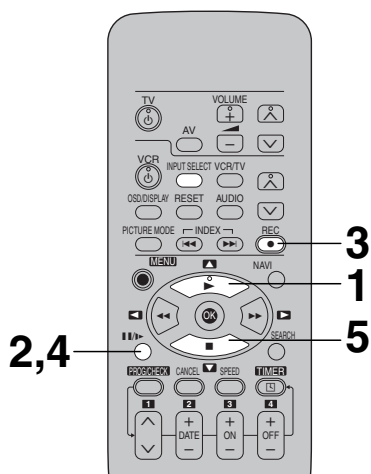

# Other Functions

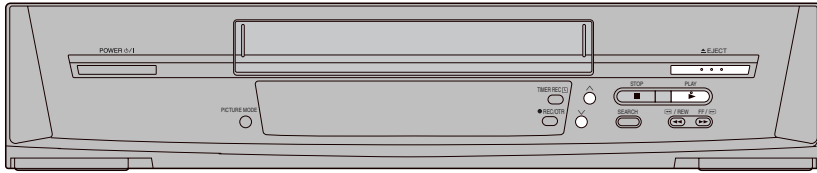

## Tracking Adjustment and Vertical Locking Adjustment

- For manual tracking adjustment  
The  $\nabla$  and  $\wedge$  buttons are used to adjust the tracking when, for example, noise bars on the picture during normal playback are better removed manually than by automatic digital tracking control. To return to automatic digital tracking control, press both buttons together.
- For slow tracking adjustment  
When noise bars appear during still or slow playback, switch over to slow playback and adjust with the  $\nabla$  and  $\wedge$  button to reduce the noise bars.
- For vertical locking adjustment  
Use the  $\nabla$  and  $\wedge$  buttons to minimize any vertical jitter during still picture playback.

## Automatic Switching Off and Ejection

When the VCR is switched off, an inserted video cassette can be ejected by simply pressing [EJECT]. The VCR will eject the video cassette and automatically turn itself off again.

## S-VHS Quasi Playback (SQPB)

- It is also possible to play back tapes recorded in the S-VHS system.
- Some picture noise may occur depending on the type of tape used.
  - It is not possible to fully obtain the high resolution that S-VHS is capable of.
  - It is not possible to record in the S-VHS system with this VCR.

## Other Automatic Functions

### Automatic Playback

When a video cassette without an erasure prevention tab is inserted, the VCR starts playback automatically.

### VCR-off Playback

When the VCR is off, an inserted video cassette can be played back by pressing [PLAY].

### Automatic Rewinding

When the tape reaches its end during recording (except for timer recording) or playback, it will automatically be rewound to the beginning. During OTR, this function will not work.



# Before Requesting Service

Before requesting service, check the following points again.

## Message of On Screen Display



On screen display messages are displayed.

The error message is indicated in brackets [ ].

[PLEASE PUT IN A VIDEO CASSETTE.]

- [REC (REC/OTR)] or [TIMER (TIMER REC)] has been pressed without a video cassette inserted.

Insert a video cassette with an intact erasure prevention tab.

[PLEASE STOP THE TAPE.]

- [CHANNEL SET] has been selected during playback. Stop the tape.

[PLEASE SET THE CLOCK.]

- [TIMER (TIMER REC)] or [PROG./CHECK] has been pressed when the clock is not set.

Set the clock.

[PLEASE USE A CASSETTE WITH TAB.]

- [REC (REC/OTR)] or [TIMER (TIMER REC)] has been pressed without a video cassette with an intact erasure prevention tab.

Use a video cassette with an intact erasure prevention tab.

[NO TIMER RECORDING HAS BEEN SET.]

- [TIMER (TIMER REC)] has been pressed with no timer programs.
- Set timer recording.

[VCR IS IN THE TIMER STANDBY MODE.]

- [POWER  $\odot$ /I (VCR  $\odot$ )] has been pressed during the timer standby mode.
- Press [TIMER (TIMER REC)] to release the VCR from the timer standby mode.

## Self-diagnostic Indications

This VCR has a self-diagnosis and display function. If the VCR detects trouble during installation or during use, the following indications automatically appear in the VCR display. Indications are in the form of a single English letter plus two numbers, such as [H01].

INDICATION: H□□, F□□

CAUSE: Some trouble has occurred. (Numbers after H and F differ according to the status of the VCR.)

REMEDY: Consult your dealer for further advice.

## The VCR will not operate correctly

The symptom description is indicated in brackets [ ].

[The VCR display is not illuminated.]

- The AC power cord has not been connected.
- Connect the AC power cord to the main AC power.

[The VCR display is illuminated but the VCR will not operate.]

- The VCR is in the timer mode. Press [TIMER (TIMER REC)] to operate the VCR manually.
- Safety devices are operating. Disconnect the AC power cord and wait for 1 minute. Reconnect the mains supply and check functions.

[An unknown language appears on the TV screen.]

- The language setting has been set to an unknown language.
- Select the desired language.
- See page 16.

### Playback will not operate correctly

The symptom description is indicated in brackets [ ].

[The picture is noisy or is not in color. Horizontal bars or lines run down the screen.]

- Tracking is not correct. Adjust the tracking. See page 35.
- The TV has not been tuned to the VCR. Tune the TV to the VCR. See page 12.
- The video heads are clogged or worn. Consult your dealer for further advice.

### Recording will not operate correctly

The symptom description is indicated in brackets [ ].

[The  indication flashes whenever recording is attempted.]

- The erasure prevention tab on the video cassette has been broken off. Use a tape with an intact erasure prevention tab, or cover the tab hole with adhesive tape, if the original recording is no longer required.

[The picture is recorded with noise or a blank screen.]

- The antenna or antenna cable is defective. Check the antenna connection to the VCR. See pages 9–10. Check your normal TV picture. If there is no picture, check your antenna.
- The VCR is not correctly tuned. Retune the VCR. See pages 12–15.
- AV input has been selected. Select the required TV program.

[Timer recording cannot be performed.]

- The clock or calendar has been incorrectly set. Check the clock and calendar. Set them to the present time. (Note that this is a 24-hour clock.) See page 17.

- The recording starting or ending time setting is incorrect. Set the recording starting and ending time correctly.
- The VCR has not been set for timer recording. Press [TIMER (TIMER REC)] after programming for timer recording.

[AV external recordings cannot be made.]

- AV input has not been selected. Select AV input by pressing [INPUT SELECT].
- External AV connections are incorrect. Check that the connections for external video and audio sources are correct. See page 34.

### The remote controller will not operate correctly

The symptom description is indicated in brackets [ ].

[The remote controller does not operate correctly.]

- The remote controller transmitter beam is not reaching the VCR. Ensure that the remote controller is being pointed at the VCR and that the transmitter beam is not obstructed.
- The distance is too far. Use the remote controller within 7 m of the VCR. If this range is not possible, replace the batteries.
- The batteries are exhausted. Replace the batteries. Note the precautions for replacement on page 8.
- The batteries are incorrectly fitted with (⊕/⊖) reversed. Fit the batteries correctly as shown on page 8.

# Usage Precautions

Please read these precautions before you operate this VCR.

## Avoid Sudden Changes in Temperature

If the VCR is suddenly moved from a cold to a warm place, dew may form on the tape and inside the VCR.

## Humidity and Dust

Avoid places where there is high humidity or much dust, which may cause damage to internal parts.

## Do Not Obstruct the Ventilation Holes

The ventilation holes prevent abnormal increases in temperature. Do not block or cover these holes. Avoid covering the holes with soft materials such as cloth or paper.

## Avoid High Temperature

Keep the VCR away from extreme heat sources such as direct sunlight, heating radiators, or closed automobiles.

## Avoid Magnets or Magnetized objects

Never bring a magnet or magnetized object near the VCR as it will adversely affect its performance of the VCR.

Keep the VCR away from other equipments as much as possible when using it, to avoid any adverse effect on performance for both the VCR and the equipment.

## Do Not Place Fingers or Other Objects Inside

Do not attempt to disassemble the VCR. Touching internal parts of this VCR is dangerous, and may cause it serious damage. There are no user serviceable parts inside.

## Avoid Water

Keep the VCR away from flower vases, tubs, sinks, etc. If liquids are spilled into the VCR, serious damage could occur. If you spill any liquid into the VCR, consult qualified service personnel.

## Lightning

To avoid damage by lightning, disconnect the aerial plug from the VCR.

## Cleaning the VCR

Wipe the VCR with a clean, dry cloth. Never use cleaning fluid or other chemicals. Do not use compressed air to remove any dust.

## Stacking

Place the VCR in a horizontal position, and do not place anything heavy on it.

## If Dew Forms in the VCR

### Dew may form in the VCR if:

- The VCR is in a room where the heater has just been turned on.
- The VCR is in a room with steam or high humidity.
- The VCR is brought from cold surroundings into a well-heated room.
- The VCR is suddenly brought from cool surroundings, such as an air-conditioned room or car, to a place which is hot and humid.

## Note:

- Do not operate the VCR for at least 1 hour if any of the above conditions occur.  
This VCR does not incorporate a dew sensor.

## Dirt on the video heads

If the video heads get dirty, pictures will not be recorded or played back clearly.  
(See the following conditions.)

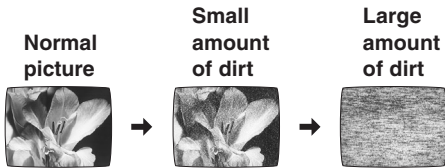

If this happens, insert and eject a cassette 5–10 times successively to remove the dirt from the video heads.

If a clear picture is not produced, insert a commercially available cleaning cassette. Then, press [REC (REC/OTR)] and keep it running for approximate 10 seconds to clean the video heads.

If the problem still persists after performing all of the measures listed above, contact a service personnel to request assistance.

Heads mainly become dirty because of scratched or dirty tapes, use of the unit in places where temperature and humidity are high, dust in the air and other reasons.

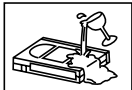

Never use tapes on which juice has been spilled or those that are extremely damaged since this will not only cause the heads to become dirty, but will also make the unit malfunction.

## Surge Absorber

For added protection for this product, these models are equipped with new surge absorbing circuit which prevents damage due to power surges caused by induced lightning.

–This function may not be effective for surges by direct lightning.

## CVC (Crystal View Control) Indicator

The crystal view control function ensures that you always obtain the optimum picture quality so that you get the best picture automatically. While the VCR is turned on, the CVC indication is always displayed to show that the Crystal View Control is activated.

## Longrun Head System

This longrun head system enables approximately 8,000 hours of recording/playback with high quality images. Newly developed head cylinder with narrower head windows and tapered cylinder design effectively protects heads from dust and prevents head clogging. Plus, “Alumina” Head Cleaner further enhanced cleaning efficiency.  
–Based on in-house tests with Panasonic video cassettes. Actual head life may vary according to conditions of use, tape type, temperature, humidity, etc.

The serial number of this product can be found on the rear panel. No others have the same serial number as yours. You should record the number and other vital information here and retain this book as a permanent record of your purchase to aid identification in case of theft.

**Date of Purchase** \_\_\_\_\_

**Dealer purchased from** \_\_\_\_\_

**Dealer Address** \_\_\_\_\_

**Dealer Phone No.** \_\_\_\_\_

**Model No.** **AG-1340P**

**Serial No.** \_\_\_\_\_

# Specifications

## AG-1340P

<b>Power Source:</b>	120 V AC 50/60Hz
<b>Power Consumption:</b>	22 W

<b>Video Recording System:</b>	2 rotary heads, helical scanning system
<b>Video Heads:</b>	4 heads
<b>Tape Speed:</b>	SP; 33.3 mm/s EP; 11.1 mm/s
<b>Tape Format:</b>	VHS tape
<b>Record/Playback Time:</b>	SP; 210 min with NV-T210 EP; 630 min with NV-T210
<b>FF/REW Time:</b>	Approx. 60 s with NV-T120

### VIDEO

<b>Television System:</b>	EIA; Standard (525 lines, 60 fields), NTSC color signal
<b>Modulation System:</b>	Luminance; FM azimuth recording Color signal; converted subcarrier phase shift recording
<b>Input Level:</b>	VIDEO IN (PHONO); 1.0 Vp-p, 75 ohm
<b>Output Level:</b>	VIDEO OUT (PHONO); 1.0 Vp-p, 75 ohm RF modulated; VHF channel US3 or 4, 75 ohm, terminated

### AUDIO

<b>Input Level:</b>	AUDIO IN (PHONO); -10 dBV, 47 kohm
<b>Output Level:</b>	AUDIO OUT (PHONO); -8 dBV, 1 kohm
<b>Audio Track:</b>	1 track (normal-mono only)

<b>Video Horizontal Resolution:</b>	Color; more than 200 lines
<b>Signal-to-Noise Ratio:</b>	Video; more than 40 dB/SP Audio; more than 40 dB/SP
<b>Audio Frequency Response:</b>	60 Hz-12 kHz/SP
<b>Operating Temperature:</b>	5°C-40°C (41°F-104°F)
<b>Operating Humidity:</b>	35%-80%
<b>Weight:</b>	3.3 kg (7.26 lbs.)
<b>Dimensions:</b>	430 (W)×87 (H)×282 (D) mm [16 <sup>5</sup> / <sub>16</sub> " (W)×3 <sup>7</sup> / <sub>16</sub> " (H)×11 <sup>1</sup> / <sub>8</sub> " (D)]

Weight and dimensions shown are approximate.  
Specifications are subject to change without notice.





---

# Panasonic

**PANASONIC BROADCAST & TELEVISION SYSTEMS COMPANY**  
DIVISION OF MATSUSHITA ELECTRIC CORPORATION OF AMERICA

**Executive Office:**

3330 Cahuenga Blvd W., Los Angeles, CA 90068 (323) 436-3500

**EASTERN ZONE:**

One Panasonic Way 4E-7, Secaucus, NJ 07094 (201) 348-7621

**Southeast Region:**

1225 Northbrook Parkway, Ste 1-160, Suwanee, GA 30024 (770) 338-6835

**Central Region:**

1707 N Randall Road E1-C-1, Elgin, IL 60123 (847) 468-5200

**WESTERN ZONE:**

3330 Cahuenga Blvd W., Los Angeles, CA 90068 (323) 436-3500

**Government Marketing Department:**

52 West Gude Drive, Rockville, MD 20850 (301) 738-3840

**Broadcast PARTS INFORMATION & ORDERING:**

9:00 a.m.–5:00 p.m. (EST) (800) 334-4881/24 Hr. Fax (800) 334-4880

Emergency after hour parts orders (800) 334-4881

**TECHNICAL SUPPORT:**

Emergency 24 Hour Service (800) 222-0741

**Panasonic Canada Inc.**

5770 Ambler Drive, Mississauga, Ontario L4W 2T3 (905) 624-5010

**Panasonic de Mexico S.A. de C.V.**

Av angel Urraza Num. 1209 Col. de Valle 03100 Mexico, D.F. (52) 1 951 2127

**Panasonic Sales Company**

**Division of Matsushita Electric of Puerto Rico Inc.**

San Gabriel Industrial Park, 65th Infantry Ave., Km. 9.5, Carolina, Puerto Rico 00630 (787) 750-4300